



HR Perilica posuđa
EN Dishwasher

Upute za uporabu 2
User Manual 22

SADRŽAJ

1. INFORMACIJE O SIGURNOSTI.....	3
2. SIGURNOSNE UPUTE.....	4
3. OPIS PROIZVODA.....	6
4. UPRAVLJAČKA PLOČA.....	7
5. PROGRAMI.....	7
6. POSTAVKE.....	8
7. PRIJE PRVE UPOTREBE.....	11
8. SVAKODNEVNA UPORABA.....	12
9. SAVJETI.....	14
10. ČIŠĆENJE I ODRŽAVANJE.....	15
11. RJEŠAVANJE PROBLEMA.....	16
12. INFORMACIJSKI LIST PROIZVODA.....	20
13. DODATNE TEHNIČKE INFORMACIJE.....	21

MISLIMO NA VAS

Hvala vam što ste kupili Electrolux uređaj. Izabrali ste proizvod koji sa sobom donosi desetljeća profesionalnog iskustva i inovacija. Domišljat i elegantan, projektiran je misleći na vas. Stoga, uvijek kada ga koristite, možete biti sigurni znajući da ćete svaki put dobiti izvrsne rezultate.

Dobrodošli u Electrolux.

Posjetite našu internetsku stranicu za:



Dobivanje savjeta o korištenju, rješavanje problema, brošure i servisne informacije:

www.electrolux.com/webselfservice



Registriranje vašeg proizvoda za bolji servis:

www.registerelectrolux.com



Kupujte dodatnu opremu, potrošni materijal i originalne rezervne dijelove za svoj uređaj:

www.electrolux.com/shop

BRIGA O KUPCIMA I SERVIS

Preporučujemo uporabu originalnih rezervnih dijelova.

Prilikom kontaktiranja ovlaštenog servisnog centra, provjerite da su vam dostupni sljedeći podaci: Model, PNC, serijski broj.

Informacije možete pronaći na natpisnoj pločici.

 Upozorenje / Oprez - sigurnosne informacije

 Opće informacije i savjeti

 Ekološke informacije

Zadržava se pravo na izmjene.

1. ⚠ INFORMACIJE O SIGURNOSTI

Prije postavljanja i korištenja uređaja, pažljivo pročitajte isporučene upute. Proizvođač nije odgovoran za bilo kakvu ozljedu ili oštećenje koji su rezultat neispravnog postavljanja ili korištenja. Upute uvijek držite na sigurnom i pristupačnom mjestu za buduću upotrebu.

1.1 Sigurnost djece i osjetljivih osoba

- Ovaj uređaj mogu koristiti djeca od 8 godina pa na više i osobe smanjenih tjelesnih, osjetilnih ili mentalnih mogućnosti ili osobe koje ne raspolažu iskustvom ili znanjem ako su pod nadzorom osobe odgovorne za njihovu sigurnost i rade po uputama koje se odnose na sigurno korištenje uređaja te razumiju uključene opasnosti.
- Djeca između 3 i 8 godina starosti i osobe s velikim i složenim invaliditetom trebaju se držati podalje od uređaja, osim ako su pod stalnim nadzorom.
- Djeca mlađa od 3 godine trebaju se držati podalje od uređaja ako nisu pod trajnim nadzorom.
- Ne dozvolite djeci da se igraju s uređajem.
- Deterdžente čuvajte izvan dohvata djece.
- Djecu i kućne ljubimce držite podalje od uređaja dok su vrata uređaja otvorena.
- Bez nadzora djeca ne smiju čistiti uređaj i provoditi održavanje koje izvršava korisnik.

1.2 Opća sigurnost

- Ovaj uređaj namijenjen je za upotrebu u kućanstvu i za slične namjene kao što su:
 - farme, čajne kuhinje koje upotrebljavaju zaposleni u prodavaonicama, uredima i drugim radnim prostorima;
 - klijenti hotela, motela, bed&breakfast ustanova i drugih vrsta smještaja.
- Ne mijenjajte specifikacije ovog uređaja.

- Radni tlak vode (minimalni i maksimalni) mora biti između 0.5 (0.05) / 8 (0.8) bar (MPa)
- Pridržavajte se postavke maksimalnog broja od 13 mjesta.
- Ako je kabel za napajanje oštećen, proizvođač ili ovlašteni servisni centar ili slična kvalificirana osoba mora ga zamijeniti kako bi se izbjegla opasnost.
- Pribor za jelo stavite u košaru za pribor za jelo s oštrim rubovima okrenutom prema dolje, ili ga stavite u ladicu za pribor za jelo u vodoravan položaj s oštrim rubovima okrenutim prema dolje.
- Ne ostavljajte uređaj s otvorenim vratima bez nadzora kako biste izbjegli da ih slučajno nagazite.
- Prije održavanja uređaj isključite, a utikač izvadite iz utičnice električnog napajanja.
- Za čišćenje uređaja ne koristite prskalice vode i/ili pare pod tlakom.
- Ako uređaj ima ventilacijske otvore na dnu, oni se ne smiju pokrivati, npr. tepihom.
- Uređaj se treba priključiti na vodovodnu mrežu pomoću isporučenog novog kompleta cijevi. Stari komplet cijevi ne smije se ponovno upotrijebiti.

2. SIGURNOSNE UPUTE

2.1 Postavljanje



UPOZORENJE!

Samo kvalificirana osoba smije postaviti ovaj uređaj.

- Odstranite svu ambalažu.
- Ne postavljajte i ne koristite oštećeni uređaj.
- Pridržavajte se uputa za ugradnju koje su priložene uređaju.
- Prilikom pomicanja uređaja uvijek budite pažljivi jer je uređaj težak. Uvijek nosite zaštitne rukavice i zatvorenu obuću.
- Uređaj nemojte postavljati na mjesta na kojima je temperatura manja od 0°C.

- Uređaj postavite na sigurno i prikladno mjesto koje zadovoljava zahtjeve za postavljanje.

2.2 Električni priključak



UPOZORENJE!

Opasnost od požara i strujnog udara.

- Uređaj mora biti uzemljen.
- Uvjerite se da su parametri na natpisnoj pločici kompatibilni s električnim detaljima napajanja.
- Uvijek koristite pravilno ugrađenu utičnicu sa zaštitom od strujnog udara.
- Ne koristite višeputne utikače i produžne kabele.

- Pazite da ne oštetite utikač i kabel napajanja. Ako je potrebno zamijeniti električni kabel, to mora izvršiti ovlašteni servisni centar.
- Utikač kabela napajanja utaknite u utičnicu tek po završetku postavljanja. Provjerite postoji li pristup utikaču nakon postavljanja.
- Ne povlačite kabel napajanja kako biste utikač izvukli iz utičnice. Uvijek uhvatite i povucite utikač.
- Ovaj uređaj opremljen je kabelom napajanja od 13 A. Ako je potrebno zamijeniti osigurač električnog utikača, upotrijebite osigurač ASTA (BS 1362) od 13 A (Samo UK i Irska).
- Deterdženti za perilicu posuđa su opasni. Slijedite sigurnosne upute na ambalaži deterdženta.
- Ne pijte i ne igrajte se s vodom u uređaju.
- Ne vadite posuđe iz uređaja prije završetka programa. Neki deterdženti mogu ostati na posuđu.
- Ne sjedajte i ne stojite na otvorenim vratima uređaja.
- Uređaj može ispuštati vruću paru ako otvorite vrata dok je program u tijeku.

2.3 Spajanje na dovod vode

- Ne oštećujte crijeva za vodu.
- Prije priključka na nove cijevi, cijevi koje dugo nisu korištene, nakon popravka ili instalacije novih uređaja (mjerila itd.), pustite da voda teče dok nije čista i bistra.
- Provjerite da nema vidljivih curenja tijekom i nakon prve uporabe uređaja.
- Ako je crijevo za dovod vode oštećeno, odmah zatvorite slavinu za vodu iskopčajte utikač iz strujne utičnice. Za zamjenu crijeva za dovod vode kontaktirajte ovlašteni servisni centar.

2.4 Upotreba

- Ne stavljajte zapaljive predmete ili predmete namočene zapaljivim sredstvima u, pored ili na uređaj.

2.5 Usluga

- Za popravak uređaja kontaktirajte ovlašteni servis.
- Koristite samo originalne rezervne dijelove.

2.6 Odlaganje



UPOZORENJE!

Opasnost od ozljede ili gušenja.

- Uređaj isključite iz električne mreže.
- Prerežite električni kabel i bacite ga.
- Uklonite bravicu vrata kako biste spriječili da se djeca i kućni ljubimci zatvore u uređaj.

3. OPIS PROIZVODA

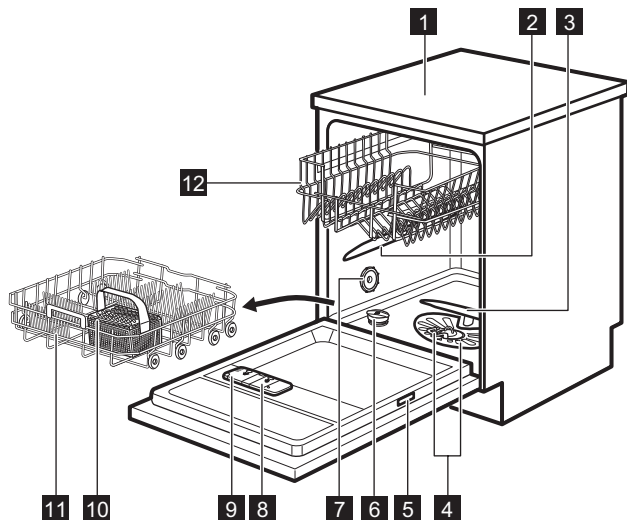



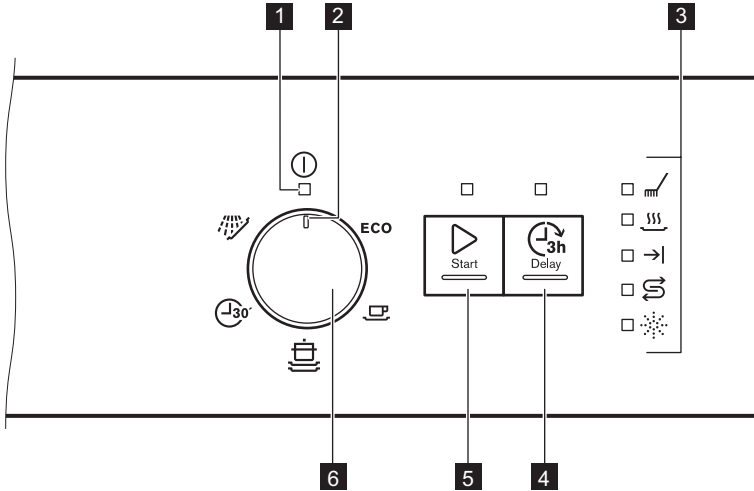

- | | |
|------------------------------|---|
| 1 Radna ploča | 8 Spremnik sredstva za ispiranje |
| 2 Gornja mlaznica | 9 Spremnik deterdženta |
| 3 Donja mlaznica | 10 Košara za pribor za jelo |
| 4 Filtri | 11 Donja košara |
| 5 Natpisna pločica | 12 Gornja košara |
| 6 Spremnik soli | |
| 7 Ventilacijski otvor | |

4. UPRAVLJAČKA PLOČA







- | | |
|---|--------------------------|
| 1 Indikator uključeno/Isključeno | 5 Tipka "Početak" |
| 2 Pokazivač programa | 6 Programator |
| 3 Indikatori | |
| 4 Tipka za odgodu početka | |

4.1 Indikatori

Indikator	Opis
	Faza pranja. Uključuje se tijekom rada faze pranja.
	Faza sušenja. Uključuje se tijekom odvijanja faze sušenja.
	Indikator završetka programa.
	Indikator sredstva za ispiranje. On je uvijek isključen dok program radi.
	Indikator za sol. On je uvijek isključen dok program radi.

5. PROGRAMI

Redosljed programa u tablici možda ne reflektira njihov redoslijed na upravljačkoj ploči.

Program	Stupanj zaprljanosti Vrsta rublja	Faze programa	Potrošnja 1)		
			Trajanje (min)	Energija (kWh)	Voda (l)
ECO 2)	Normalno zaprljano Posuđe i pribor za jelo	<ul style="list-style-type: none"> • Predpranje • Pranje 50 °C • Ispiranja • Sušenje 	227	1.039	11
	Jako zaprljano Posuđe, pribor za jelo, tave i posude	<ul style="list-style-type: none"> • Predpranje • Pranje 70 °C • Ispiranja • Sušenje 	155 - 170	1.5 - 1.7	14 - 15
	Normalno zaprljano Posuđe i pribor za jelo	<ul style="list-style-type: none"> • Predpranje • Pranje 65 °C • Ispiranja • Sušenje 	130 - 140	1.4 - 1.6	15 - 17
 3)	Svježe zaprljano posuđe Posuđe i pribor za jelo	<ul style="list-style-type: none"> • Pranje 60 °C ili 65 °C • Ispiranja 	30	0.8	10
 4)	Sve	<ul style="list-style-type: none"> • Predpranje 	14	0.1	5

1) Tlak i temperatura vode, oscilacije u napajanju električne mreže, opcije te količina posuđa mogu promijeniti vrijednosti.

2) Ovaj program nudi najučinkovitije iskorištavanje vode i štednju energije za uobičajeno zaprljano posuđe i pribor za jelo. Ovo je standardni program za ustanove za testiranje.

3) Taj program prikladan je za kratko pranje cijelog ili polovice punjenja s lagano ili normalno zaprljanim rubljem.

4) S ovim programom možete brzo isprati sve ostatke hrane s posuđa i spriječiti stvaranje mirisa u uređaju. Uz ovaj program nemojte koristiti deterdžent.

5.1 Informacije za ustanove za testiranje

Kako biste primili potrebne informacije o provedbi testova značajki (npr. u skladu s EN60436), pošaljite poruku elektroničke pošte na:

info.test@dishwasher-production.com

U vašem zahtjevu priložite broj proizvoda (PNC) s natpisne pločice.

Za sva druga pitanja u vezi vaše perilice posuđa pogledajte servisnu knjižicu isporučenu s vašim uređajem.

6. POSTAVKE

6.1 Način rada za odabir programa i korisnički način rada

Kad je uređaj u načinu rada za odabir programa, moguće je postaviti program i ući u korisnički način rada.

Postavke dostupne u korisničkom načinu rada:

- Razina omekšivača vode u skladu s tvrdoćom vode.
- Uključenje ili isključenje AirDry

Zbog toga što uređaj pohranjuje spremljene postavke, nije ga potrebno konfigurirati prije svakog ciklusa.

Kako postaviti način rada za odabir programa

Uređaj je u načinu rada odabir programa kada se uključi indikator uključeno/isključeno i kada započne bljeskati indikator Start.

Nakon uključjenja, uređaj je standardno u načinu rada za odabir programa. Ako nije, postavite način rada za odabir programa na sljedeći način:

Istodobno pritisnite i držite **Start** i **Delay** dok uređaj ne prijeđe u način rada za odabir programa.

Što je više tih minerala, to je voda tvrđa. Tvrdoća vode mjeri se sljedećim ekvivalentnim ljestvicama.

Omekšivač vode treba podesiti u skladu s tvrdoćom vode na vašem području. Podatke možete dobiti od lokalnog vodoopskrbnog poduzeća. Važno je postaviti ispravnu razinu omekšivača vode kako bi se osigurali dobri rezultati pranja.



Uključenje opcija često povećava potrošnju vode i električne energije, kao i trajanje programa. Što je viša razina omekšivača vode, potrošnja je veća a trajanje duže.

6.2 Omekšivač vode

Omekšivač vode uklanja minerale iz vode koji bi imali negativan utjecaj na rezultate pranja i na uređaj.

Tvrdoća vode

Njemački stupnjevi (°dH)	Francuski stupnjevi (°fH)	mmol / l	Clarke stupnjevi	Razina omekšivača vode
47 - 50	84 - 90	8.4 - 9.0	58 - 63	10
43 - 46	76 - 83	7.6 - 8.3	53 - 57	9
37 - 42	65 - 75	6.5 - 7.5	46 - 52	8
29 - 36	51 - 64	5.1 - 6.4	36 - 45	7
23 - 28	40 - 50	4.0 - 5.0	28 - 35	6
19 - 22	33 - 39	3.3 - 3.9	23 - 27	5 1)
15 - 18	26 - 32	2.6 - 3.2	18 - 22	4
11 - 14	19 - 25	1.9 - 2.5	13 - 17	3
4 - 10	7 - 18	0.7 - 1.8	5 - 12	2
<4	<7	<0.7	< 5	1 2)

1) Tvorničke postavke.

2) Nemojte koristiti sol na ovoj razini.

Neovisno o vrsti korištenog deterđenta, postavite odgovarajuću tvrdoću vode kako biste održavali indikator dopunjevanja soli aktivnim.



Višenamjenske tablete koje sadrže sol nisu dovoljno učinkovite za omekšavanje tvrde vode.

Kako postaviti razinu omekšivača vode

Uređaj mora biti u načinu rada odabira programa.

1. Povjerite je li pokazivač programa na programatoru poravnat s položajem uklj./isklj..
2. Za ulazak u korisnički način rada pritisnite i držite **Delay**. Istovremeno okrećite regulator u smjeru suprotnom od smjera kazaljke na satu dok pokazivač programa ne prikazuje prvi program. Otpustite **Delay** kad indikatori **Start** i uklj./isklj. počnu bljeskati.
 - Isprekidano bljeskanje →| prikazuje trenutnu postavku, npr. 5 bljeskova + pauza + 5 bljeskova = razina 5.
3. Uzastopce pritišćite **Delay** za promjenu postavke. Svaki pritisak **Delay** povećava broj razine. Nakon dostizanja 10. razine, brojenje ponovno počinje od razine 1.
4. Za potvrdu postavke okrećite programator sve dok pokazivač programa nije ponovno u položaju uklj./isklj.

6.3 AirDry

Opcija AirDry poboljšava rezultate sušenja uz manju potrošnju energije.

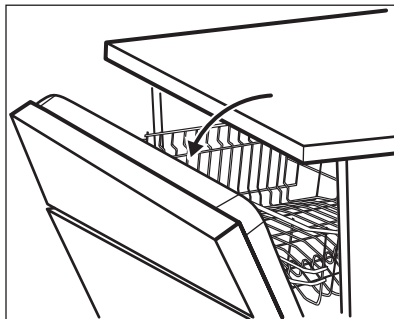

Tijekom faze sušenja, vrata se automatski otvaraju i ostaju pritvorena.



OPREZ!

Ne pokušavajte zatvoriti vrata uređaja tijekom 2 minute nakon automatskog otvaranja. To može prouzročiti oštećenja uređaja.

AirDry automatski se aktivira sa svim programima osim  (ako je primjenjivo).



OPREZ!

Ako djeca imaju pristup uređaju, preporučuje se isključiti AirDry jer otvaranje vrata može predstavljati opasnost.

Kako isključiti AirDry

Uređaj mora biti u načinu rada odabira programa.

Povjerite je li pokazivač programa na programatoru poravnat s položajem uklj./isklj..

1. Za ulazak u korisnički način rada pritisnite i držite **Delay**. Istovremeno okrećite regulator u smjeru suprotnom od smjera kazaljke na satu dok pokazivač programa ne prikazuje prvi program. Otpustite **Delay** kad indikatori **Start** i uklj./isklj. počnu bljeskati.
2. Okrenite tipku u smjeru suprotno od kazaljki na satu, dok pokazivač programa ne prikazuje drugi program.
 - Indikator →| prikazuje trenutnu postavku: uklj = AirDry je uključeno.
3. Za promjenu postavke pritisnite **Delay**.
 - Ako je indikator →| isklj. = AirDry je isključeno.
4. Za potvrdu postavke nastavite okretati programator sve dok pokazivač programa nije natrag u položaju uklj./isklj..

7. PRIJE PRVE UPOTREBE

1. **Provjerite odgovara li trenutna postavka omekšivača vode tvrdoći vode. Ako nije, prilagodite razinu omekšivača vode.**
2. Napunite spremnik za sol.
3. Napunite spremnik sredstva za ispiranje.
4. Otvorite slavinu.
5. Pokrenite program za uklanjanje svih zaostalih ostataka koji mogu biti u uređaju. Ne koristite deterdžent i ne stavljajte posuđe u košare.

Nakon pokretanja programa, uređaj puni smolu u omekšivač vode, do 5 minuta. Faza pranja započinje tek kada se ovaj postupak dovrši. Postupak se periodički ponavlja.

7.1 Spremnik za sol



OPREZ!

Koristite samo grubu sol namijenjenu za perilice posuđa. Fina sol povećava rizik od korozije.

Sol se koristi za nadopunu smole u omekšivač vode te kako bi se osigurali dobri rezultati pranja u svakodnevnoj uporabi.

Kako puniti spremnik za sol

1. Okrenite poklopac spremnika za sol u smjeru suprotnom od smjera kazaljke na satu i skinite ga.
2. Stavite 1 litru vode u spremnik za sol (samo prvi put).
3. Spremnik za sol napunite s 1 kg soli (dok se ne napuni).

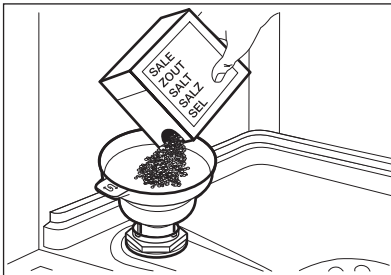

4. Pažljivo protresite cijev za ručicu, da zrnca uđu unutra.
5. Uklonite sol oko otvora spremnika za sol.

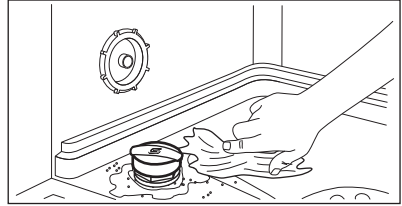

6. Okrenite čep spremnika za sol u smjeru kazaljke na satu kako biste ga zatvorili.



OPREZ!

Voda i sol mogu izlaziti iz spremnika za sol tijekom punjenja. Nakon što napunite spremnik za sol odmah pokrenite program kako biste spriječili koroziju.

7.2 Kako napuniti spremnik sredstva za ispiranje

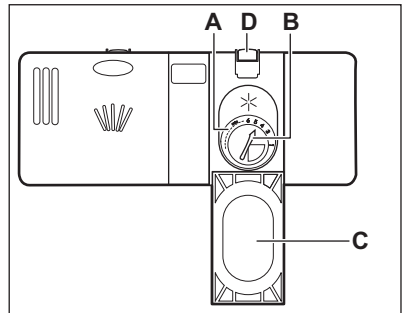

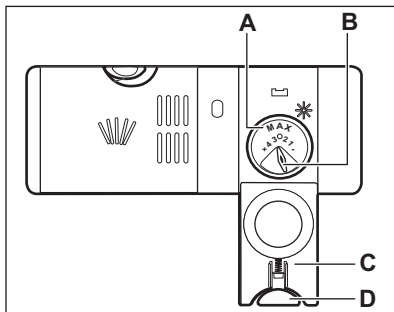
**OPREZ!**

Koristite isključivo sredstva za ispiranje posebno napravljena za perilice posuda.

1. Pritisnite tipku (D) za otvaranje poklopca (C).
2. Ulijte sredstvo za ispiranje u spremnik (A) dok tekućina ne dosegne razinu napunjenosti 'max'.
3. Proliveno sredstvo za ispiranje uklonite upijajućom krpom kako biste spriječili stvaranje prevelike količine pjene.
4. Zatvorite poklopac. Provjerite da se tipka za otpuštanje zaključava na mjestu.



Možete okrenuti birač ispuštene količine (B) između položaja 1 (najmanja količina) i položaja 4 ili 6 (najveća količina).

8. SVAKODNEVNA UPORABA

1. Otvorite slavinu.
2. Okrećite programator dok se pokazivač programa ne poravna s programom kojeg želite postaviti. Postavite program koji odgovara vrsti i zaprljanosti punjenja.
 - Ako je indikator soli uključen, napunite spremnik za sol.
 - Ako je indikator sredstva za ispiranje uključen, napunite spremnik sredstva za ispiranje.
3. Napunite košare.
4. Dodajte deterdžent.
5. Pokrenite program.

8.1 Upotreba deterdženta

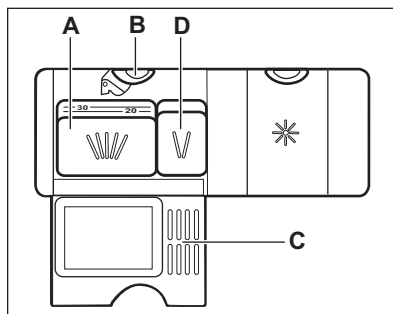
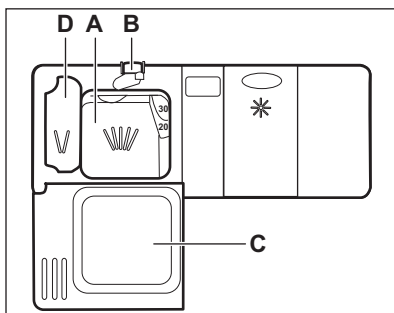

1. Pritisnite tipku (B) za otvaranje poklopca (C).
2. Stavite deterdžent u prašku ili tablete u odjeljak (A).
3. Ako program pranja ima fazu pretpranja, stavite malu količinu deterdženta u spremnik (D).
4. Zatvorite poklopac. Provjerite da se tipka za otpuštanje zaključava na mjestu.

8.2 Uporaba kombiniranih tableta s deterdžentom

Kada upotrebljavate tablete koje sadrže sol i sredstvo za ispiranje, nemojte puniti spremnik za sol i spremnik sredstva za ispiranje.

1. Omekšivač vode postavite na najnižu razinu.
2. Postavite spremnik sredstva za ispiranje u najniži položaj.

8.3 Odabir i pokretanje programa

Pokretanje programa

1. Otvorite slavinu.
2. Zatvorite vrata uređaja.
3. Okrećite programator dok se pokazivač programa ne poravnava s programom kojeg želite postaviti.
 - Uključuje se indikator uključeno/isključeno.
 - Indikator započinje bljeskati.
4. Pritisnite **Start**.
 - Program se pokreće i uključuje se indikator faze pranja u tijeku.
 - Uključeni su indikator uključeno/isključeno i indikator pokretanja.

Pokretanje programa s odgodom početka

1. Postavite program.
2. Pritisnite **Delay** za odgodu početka programa pranja za 3 sata.

Indikator odgode se uključuje.

3. Pritisnite **Start**.

Uključuje se indikator pokretanja.

Kada odbrojavanje završi, program se pokreće.

Otvaranje vrata dok uređaj radi

Otvaranje vrata dok je program u tijeku zaustavlja uređaj. To može utjecati na potrošnju energije i trajanje programa. Nakon zatvaranja vrata, uređaj nastavlja raditi od točke u kojoj je prekinuo rad.



Ako su vrata otvorena dulje od 30 sekundi tijekom faze sušenja, program u tijeku će se prekinuti. To se neće dogoditi ako je vrata otvorila funkcija AirDry.



Ne pokušavajte otvoriti vrata uređaja tijekom 2 minute nakon što ih automatski otvori AirDry jer bi to moglo uzrokovati oštećenje uređaja.

Ako se nakon toga vrata zatvore na još 3 minute, program koji u tijeku prekida se.

Poništavanje odgode početka tijekom odbrojavanja

1. Pritisnite i držite pritisnutim **Start** i **Delay** sve dok indikator pokretanja započne bljeskati.
2. Pritisnite **Start** za pokretanje programa.

Otkazivanje programa

Pritisnite i držite pritisnutim **Start** i **Delay** sve dok indikator pokretanja započne bljeskati.

Prije pokretanja novog programa provjerite nalazi li se deterdžent u spremniku za deterdžent.

Završetak programa

Kada program završi, uključuje se indikator →|. Nakon 5 minuta bez uporabe, uređaj ulazi u stanje pripravnosti i svi indikatori se isključuju. To smanjuje potrošnju energije.

1. Za isključivanje uređaja programator okrećite sve dok pokazivač programa nije u položaju uklj./isklj.
2. Zatvorite slavinu.

9. SAVJETI

9.1 Općenito

Slijedite savjete ispod kako biste osigurali optimalne rezultate pranja i sušenja u svakodnevnoj upotrebi te pomoći u očuvanju okoliša.

- Veće naslage hrane s posuđa bacite u kantu za smeće.
- Ne ispirite posuđe ručno prije stavljanja u perilicu. Kad je potrebno, odaberite program s fazom predpranja.
- Uvijek upotrijebite cijeli prostor košara.
- Pazite da se predmeti u košari međusobno ne dodiruju ili ne prekrivaju. Samo tada voda može u potpunosti dosegnuti i oprati posuđe.
- Možete odvojeno upotrebljavati deterdžent za perilice posuđa, sredstvo za ispiranje i sol za perilice posuđa ili možete upotrebljavati višenamjenske tablete s deterdžentom (npr. "Sve u 1"). Slijedite upute na pakiranju.
- Odaberite program u skladu s vrstom rublja i stupnjem onečišćenja.

ECO nudi najučinkovitiju uporabu vode i potrošnju energije.

9.2 Upotreba soli, sredstva za ispiranje i deterdženta

- Upotrebljavajte samo sol, sredstvo za ispiranje i deterdžent za perilice posuđa. Ostali proizvodi mogu prouzročiti oštećenja na uređaju.
- Za optimalne rezultate pranja i sušenja u područjima s vrlo tvrdom vodom preporučujemo uporabu običnog deterdženta za perilice posuđa (u prašku, gelu, tabletama bez dodatnih funkcija), sredstva za ispiranje i soli za perilice posuđa odvojeno.
- Najmanje jednom mjesečno pokrenite uređaj sa sredstvom za čišćenje koje je posebno prikladno za tu svrhu.
- Tablete s deterdžentom ne otapaju se do kraja prilikom korištenja kratkih programa. Kako bi se spriječila pojava tragova deterdženta na posuđu

preporučujemo upotrebu sredstva za pranje u tabletama samo za duže programe pranje.

- Nemojte koristiti više od točne količine deterdženta. Pogledajte upute na pakiranju deterdženta.

9.3 Što napraviti ako želite prestati upotrebljavati kombinirane tablete

Prije nego što započnete odvojeno upotrebljavati deterdžent, sol i sredstvo za ispiranje učinite sljedeće:

1. Postavite najvišu razinu omekšivača vode.
2. Provjerite jesu li spremnik za sol i spremnik sredstvo za ispiranje puni.
3. Pokrenite najkraći program s fazom ispiranja. Ne dodajte deterdžent i ne punite košare.
4. Kada program završi, podesite omekšivač vode prema tvrdoći vode u vašem području.
5. Podesite ispuštenu količinu sredstva za ispiranje.

9.4 Punjenje košara

- Uređaj koristite samo za pranje predmeta sigurnih za pranje u perilici posuđa.
- U uređaju ne perite predmete od drveta, roga, aluminijske, kositra i bakra.
- Nemojte u uređaju prati predmete koji mogu apsorbirati vodu (spužve, kućanske krpe).
- Sa posuđa uklonite velike ostatke hrane.
- Prije pranja u uređaju, potopite posuđe sa zagorenom hranom u vodi.
- Stavite šuplje predmete (šalice, čaše i lonce) otvorom okrenutim prema dolje.
- Provjerite da se stakleni predmeti ne dodiruju.
- Lagano posuđe stavite u gornju košaru. Pazite da se posuđe ne može slobodno pomicati.
- Pribor za jelo i male predmete stavite u košaru za pribor za jelo.
- Prije početka programa provjerite mogu li se mlaznice slobodno kretati.

9.5 Prije pokretanja programa

Prije pokretanja odabranog programa, uvjerite se da:

- su filtri čisti i pravilno postavljeni.
- je poklopac spremnika za sol čvrsto zatvoren.
- mlaznice nisu začepljene.
- u uređaju ima dovoljno soli za perilicu posuđa i sredstva za ispiranje (osim ako koristite višenamjenske tablete).
- je položaj predmeta u košari ispravan.
- je program prikladan za vrstu rublja i stupanj zaprljanosti.

- Upotrebljava se odgovarajuća količina deterdženta.

9.6 Pražnjenje košara

1. Ostavite posuđe da se ohladi prije nego ga izvadite iz uređaja. Vrući predmeti mogu se lako oštetiti.
2. Prvo ispraznite donju košaru, zatim gornju košaru.

- i** Nakon završetka programa, na unutarnjim površinama uređaja još se može zadržavati voda.

10. ČIŠĆENJE I ODRŽAVANJE



UPOZORENJE!

Prije održavanja, uređaj isključite i utikač izvucite iz utičnice mrežnog napajanja.



Nečisti filtri i začepljene mlaznice smanjuju rezultate pranja. Redovno ih provjeravajte i ako je potrebno očistite ih.

10.1 Čišćenje filtera

Sustav filtra sastoji se od 3 dijela.

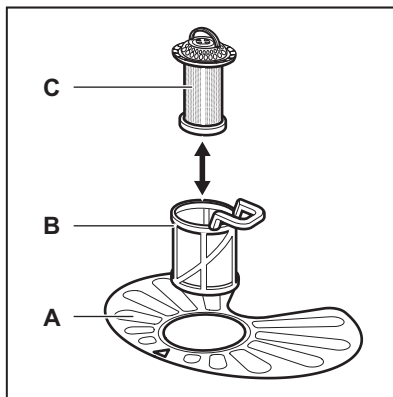

1. Okrenite filter (B) u smjeru suprotnom od smjera kazaljki na satu i skinite ga.

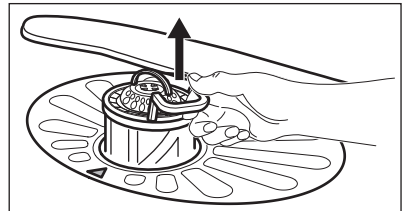
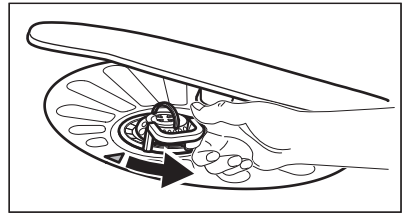

2. Izvadite filter (C) iz filtra (B).
3. Skinite plosnati filter (A).

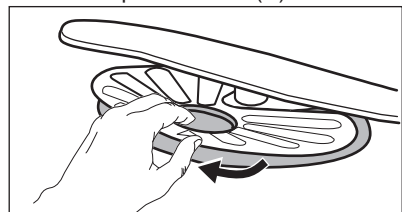

4. Operite filtre.

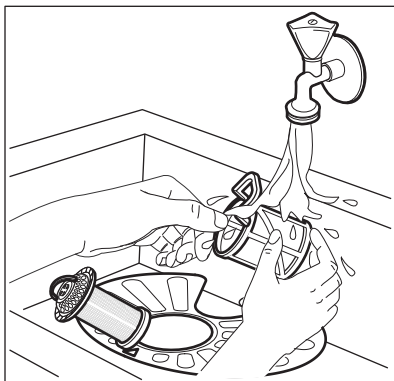

5. Provjerite da u ili oko ruba dna nema ostataka hrane ili prljavštine.
6. Vratite plosnati filtar na mjesto (A). Osigurajte da je pravilno postavljen ispod 2 vodilice.

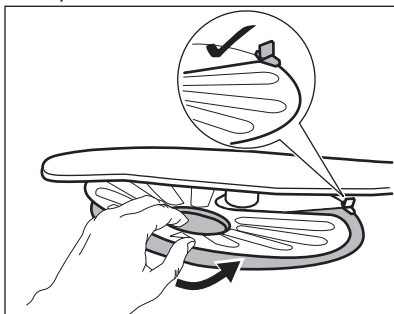

7. Sastavite filtre (B) i (C).
8. Vratite filtar (B) u plosnati filtar (A). Okrenite ga u smjeru kazaljki na satu dok se ne zaključa.

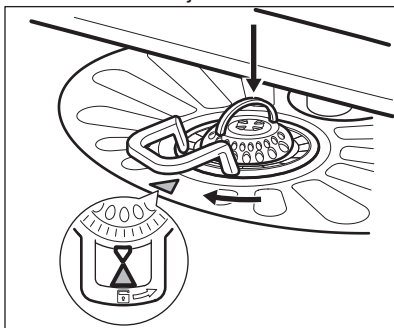
**OPREZI!**

Neispravan položaj filtera može uzrokovati slabe rezultate pranja i oštećenje uređaja.

10.2 Čišćenje mlaznica

Ne uklanjajte mlaznice. Ako se otvori u mlaznicama začepe, uklonite ostatke zaprljanja tankim oštrim predmetom.

10.3 Vanjsko čišćenje

- Uređaj očistite vlažnom mekom krpom.
- Koristite isključivo neutralni deterdžent.
- Nikada ne koristite abrazivna sredstva, jastučice za ribanje ili otapala.

10.4 Unutrašnje čišćenje

- Mekom i vlažnom krpom pažljivo očistite uređaj uključujući i gumenu brtvu na vratima.
- Ako redovito upotrebljavate program kratkog trajanja, može doći do taloženja masnoća i kamena unutar uređaja. Kako bi se to spriječilo, preporučujemo da najmanje 2 puta mjesečno pokrenete program s dugim trajanjem.
- Za održavanje najboljih značajki vašeg uređaja preporučujemo da jednom mjesečno koristite posebno sredstvo za čišćenje perilica posuđa. Pažljivo slijedite upute na pakiranju proizvoda.

11. RJEŠAVANJE PROBLEMA

Ako uređaj ne započinje s radom ili se zaustavlja tijekom rada, prije

kontaktiranja servisnog centra provjerite možete li sami riješiti problem pomoću informacija u tablici.



UPOZORENJE!

Popravci koji nisu ispravno provedeni mogu dovesti do ozbiljnog rizika za korisnika. Sve popravke mora provoditi kvalificirano osoblje.

Ako se pojave određeni problemi, indikator kraja programa isprekidano treperi ukazujući na kvar.

Većinu problema moguće je riješiti bez potrebe kontaktiranja ovlaštenog servisnog centra.

Problem i šifra alarma	Mogući uzrok i rješenje
Uređaj ne možete uključiti.	<ul style="list-style-type: none"> • Provjerite je li kabel mrežnog napajanja uključen u utičnicu. • Provjerite da u kutiji s osiguračima nema oštećenog osigurača.
Program ne započinje s radom.	<ul style="list-style-type: none"> • Provjerite jesu li vrata uređaja zatvorena. • Pritisnite Start. • Ako je postavljena odgoda početka, poništite postavku ili pričekajte završetak odbrojavanja. • Uređaj je započeo postupak nadopune smole u omekšivaču vode. Postupak traje približno 5 minuta.
Uređaj se ne puni vodom. <ul style="list-style-type: none"> • Indikator kraja programa isprekidano 1 put zatreperi. • Indikator Start kontinuirano treperi. 	<ul style="list-style-type: none"> • Provjerite je li slavina otvorena. • Provjerite da tlak dovoda vode nije prenizak. Ovu informaciju potražite kod lokalnog distributera vode. • Provjerite da slavina nije začepljena. • Provjerite da filter u dovodnom crijevu nije začepljen. • Provjerite da dovodno crijevo nije prignječeno ili savijeno.
Uređaj ne odvodi vodu. <ul style="list-style-type: none"> • Indikator kraja programa isprekidano 2 puta zatreperi. • Indikator Start kontinuirano treperi. 	<ul style="list-style-type: none"> • Provjerite da sifon nije začepljen. • Provjerite da odvodno crijevo nije prignječeno ili savijeno.
Uključen je uređaj za zaštitu od poplave. <ul style="list-style-type: none"> • Indikator kraja programa isprekidano 3 puta zatreperi. • Indikator Start kontinuirano treperi. 	<ul style="list-style-type: none"> • Zatvorite slavinu za vodu i obratite se ovlaštenom servisnom centru.
Tijekom rada uređaj se više puta zaustavlja i pokreće.	<ul style="list-style-type: none"> • To je normalno. On osigurava optimalne rezultate čišćenja i uštedu energije.

Problem i šifra alarma	Mogući uzrok i rješenje
Program predugo traje.	<ul style="list-style-type: none"> Ako je postavljena opcija odgode početka, poništite postavku odgode ili pričekajte za vršetak odbrojavanja.
Postoji malo curenje iz vrata uređaja.	<ul style="list-style-type: none"> Uređaj nije dobro niveliran. Otpustite ili pritegnite prilagodljivu nožicu (ako je primjenjivo). Vrata uređaja nisu centrirana u unutrašnjosti. Podesite stražnju nožicu (ako je primjenjivo).
Vrata uređaja teško se zatvaraju.	<ul style="list-style-type: none"> Uređaj nije dobro niveliran. Otpustite ili pritegnite prilagodljivu nožicu (ako je primjenjivo). Dijelovi posuđa i pribora za jelo strše iz košara.
Iz uređaja se čuje zvuk zveckanja/ kucanja.	<ul style="list-style-type: none"> Posuđe i pribor za jelo u košarama nisu ispravno raspoređeni. Pogledajte letak za punjenja košara. Pazite da se mlaznice mogu slobodno vrtjeti.
Uređaj uzrokuje iskakanje sklopke.	<ul style="list-style-type: none"> Jakost struje nije dovoljna za istodobnu opskrbu svih uređaja u upotrebi. Provjerite amperažu utičnice i kapacitet mjerača ili isključite jedan od uređaja koji radi. Interni električni kvar uređaja. Obratite se ovlaštenom servisnom centru.



Za druge moguće uzroke pogledajte "**Prije prve uporabe**", "**Svakodnevna uporaba**" ili "**Savjeti**".

Za šifre alarma koje nisu opisane u tablici, kontaktirajte ovlašteni servisni centar.

Kad ste provjerili uređaj, pritisnite **Start**.
Ako i dalje dolazi do kvara, obratite se servisnom centru.

11.1 Rezultati pranja i sušenja nisu zadovoljavajući

Problem	Mogući uzrok i rješenje
Slabi rezultati pranja.	<ul style="list-style-type: none"> Pogledajte "Svakodnevna uporaba", "Savjeti" i letak za punjenja košara. Koristite intenzivnije programe pranja. Čistite mlaznice i filter. Pogledajte poglavlje "Održavanje i čišćenje".

Problem	Mogući uzrok i rješenje
Slabi rezultati sušenja.	<ul style="list-style-type: none"> • Posuđe i pribor predugo su ostavljeni u zatvorenom uređaju. • Nema sredstva za ispiranje ili njegova količina nije dovoljna. Spremnik sredstva za ispiranje postavite na višu razinu. • Plastične predmete možda je potrebno osušiti ručnikom. • Za najbolju učinkovitost čišćenja uključite AirDry. • Preporučujemo da uvijek koristite sredstvo za ispiranje, čak i u kombinaciji s višenamjenskim tabletama.
Bijele crte i mrlje ili plavičasti slojevi na čašama i posuđu.	<ul style="list-style-type: none"> • Ispuštena količina sredstva za ispiranje je prevelika. Postavite količinu sredstva za ispiranje na nižu razinu. • Količina deterdženta bila je prevelika.
Na čašama i posuđu ostaju mrlje i osušene kapljice vode.	<ul style="list-style-type: none"> • Ispuštena količina sredstva za ispiranje nije dovoljna. Postavite količinu sredstva za ispiranje na višu razinu. • Uzrok može biti kvaliteta sredstva za ispiranje.
Posuđe je mokro.	<ul style="list-style-type: none"> • Za najbolju učinkovitost čišćenja uključite AirDry. • Program nema fazu sušenja ili ima fazu sušenja s niskom temperaturom. • Spremnik sredstva za ispiranje je prazan. • Uzrok može biti kvaliteta sredstva za ispiranje. • Uzrok može biti kvaliteta kombiniranog deterdženta u tabletama. Isprobajte drugu marku ili aktivirajte spremnik sredstva za ispiranje i koristite sredstvo za ispiranje zajedno s kombiniranim deterdžentom u tabletama.
Unutrašnjost uređaja mokra je.	<ul style="list-style-type: none"> • Ne radi se o kvaru uređaja, već je tome uzrok vlaga u zraku koja se kondenzira na stjenkama.
Neuobičajena pjena tijekom pranja.	<ul style="list-style-type: none"> • Koristite isključivo deterdžent za perilice posuđa. • U spremniku sredstva za ispiranje postoji curenje. Kontaktirajte ovlaštenu servisnu centar.
Tragovi hrđe na priboru za jelo.	<ul style="list-style-type: none"> • U vodi za pranje korišteno je previše soli. Pogledajte poglavlje “Omekšivač vode”. • Pribor za jelo od srebra i nehrđajućeg čelika nije postavljen odvojeno. Izbjegavajte postavljanje predmeta od srebra i nehrđajućeg čelika međusobno blizu.
Na kraju programa postoje ostaci deterdženta u spremniku.	<ul style="list-style-type: none"> • Tableta s deterdžentom se zaglavila u spremniku i zato nije potpuno ispravna vodom. • Voda ne može isprati deterdžent iz spremnika. Pazite da mlaznica nije blokirana ili začepljena. • Pazite da predmeti u košarama ne sprječavaju otvaranje poklopca spremnika za deterdžent.

Problem	Mogući uzrok i rješenje
Unutrašnjost uređaja neugodno miriše.	<ul style="list-style-type: none"> • Pogledajte “Unutrašnje čišćenje”.
Naslage kamenca na posudu i priboru za jelo, u unutrašnjosti uređaja i na unutrašnjosti vrata.	<ul style="list-style-type: none"> • Razina soli je niska; provjerite indikator za dodavanje soli. • Poklopac spremnika za sol je labav. • Voda iz slavine je tvrda. Pogledajte poglavlje “Omekšivač vode”. • Čak i uz kombinirane tablete koristite sol i postavite regeneraciju omekšivača vode. Pogledajte poglavlje “Omekšivač vode”. • Ako naslage kamenca i dalje postoje, očistite uređaj sredstvom za čišćenje uređaja koje je posebno prikladno za tu svrhu. • Isprobajte drugi deterdžent. • Obratite se proizvođaču deterdženta.
Posuđe i pribor za jelo bez sjaja su, promijenjenih boja i otkrhnuti.	<ul style="list-style-type: none"> • Pazite da u uređaju perete samo predmete koji su prikladni za pranje u perilici posuđa. • Pažljivo punite i praznite košaru. Pogledajte letak za punjenja košara. • Osjetljive predmete stavite u gornju košaru.



Za druge moguće uzroke pogledajte “**Prije prve uporabe**”, “**Svakodnevna uporaba**” ili “**Savjeti**”.

12. INFORMACIJSKI LIST PROIZVODA

Naziv dobavljača ili zaštitni znak	Electrolux
Model	ESF5206LOW 911519220
Nazivni kapacitet (broj standardnih kompleta posuđa za standardni ciklus pranja)	13
razred energetske učinkovitosti	A+
Potrošnja energije u kWh godišnje, na osnovi 280 standardnih ciklusa pranja uz uporabu hladne vode i potrošnju uz načine rada sa smanjenom snagom. Stvarna potrošnja energije ovisiti će o načinu uporabe uređaja.	295
Potrošnja energije standardnog ciklusa pranja (kWh)	1.039
Potrošnja energije u stanju isključenosti (W)	0.50
Potrošnja energije u stanju mirovanja (W)	5.0

Potrošnja vode u litrama godišnje na osnovi 280 standardnih ciklusa pranja. Stvarna potrošnja vode ovisiti će o načinu uporabe uređaja.	3080
Razred učinkovitosti sušenja na skali od G (najniža učinkovitost) do A (najviša učinkovitost)	A
"Standardni program" je standardni ciklus pranja na koji se odnose informacije na etiketi i u podacima o uređaju. Taj program prikladan je za pranje normalno zaprljanog pribora za jelo i najučinkovitiji je program u pogledu kombinirane potrošnje energije i vode. Označen je kao "Eko" program.	ECO
Trajanje programa za standardni ciklus pranja izražen u minutama	227
Trajanje stanja mirovanja u minutama	5
Razina snage zvuka (db(A) re 1pW)	49
Kućanski uređaj namijenjen za ugradnju D/N	Ne

13. DODATNE TEHNIČKE INFORMACIJE

Dimenzije	Širina / visina / dubina (mm)	600 / 850 / 625
Spajanje na električnu mrežu ¹⁾	Napon (V)	220 - 240
	Frekvencija (Hz)	50
Tlak dovoda vode	Min. / maks. bar (MPa)	0.5 (0.05) / 8 (0.8)
Dovod vode	Hladna ili topla voda ²⁾	maks. 60 °C

¹⁾ Pogledajte nazivnu pločicu za ostale vrijednosti.

²⁾ Ako topla voda dolazi iz alternativnih izvora energije (npr. solarni paneli), upotrijebite toplu vodu kako biste smanjili potrošnju energije.

14. BRIGA ZA OKOLIŠ

Reciklirajte materijale sa simbolom . Ambalažu za recikliranje odložite u prikladne spremnike. Pomozite u zaštiti okoliša i ljudskog zdravlja, kao i u recikliranju otpada od električnih i elektroničkih uređaja. Uređaje označene

simbolom  ne bacajte zajedno s kućnim otpadom. Proizvod odnesite na lokalno reciklažno mjesto ili kontaktirajte nadležnu službu.

CONTENTS

1. SAFETY INFORMATION.....	23
2. SAFETY INSTRUCTIONS.....	24
3. PRODUCT DESCRIPTION.....	26
4. CONTROL PANEL.....	27
5. PROGRAMMES.....	27
6. SETTINGS.....	28
7. BEFORE FIRST USE.....	30
8. DAILY USE.....	32
9. HINTS AND TIPS.....	33
10. CARE AND CLEANING.....	34
11. TROUBLESHOOTING.....	36
12. PRODUCT INFORMATION SHEET	39
13. ADDITIONAL TECHNICAL INFORMATION.....	40

WE'RE THINKING OF YOU

Thank you for purchasing an Electrolux appliance. You've chosen a product that brings with it decades of professional experience and innovation. Ingenious and stylish, it has been designed with you in mind. So whenever you use it, you can be safe in the knowledge that you'll get great results every time.

Welcome to Electrolux.

Visit our website for:



Get usage advice, brochures, trouble shooter, service information:
www.electrolux.com/webselfservice



Register your product for better service:
www.registerelectrolux.com



Buy Accessories, Consumables and Original spare parts for your appliance:
www.electrolux.com/shop

CUSTOMER CARE AND SERVICE

Always use original spare parts.

When contacting our Authorised Service Centre, ensure that you have the following data available: Model, PNC, Serial Number.

The information can be found on the rating plate.

 Warning / Caution-Safety information

 General information and tips

 Environmental information

Subject to change without notice.

1. ⚠ SAFETY INFORMATION

Before the installation and use of the appliance, carefully read the supplied instructions. The manufacturer is not responsible for any injuries or damage that are the result of incorrect installation or usage. Always keep the instructions in a safe and accessible location for future reference.

1.1 Children and vulnerable people safety

- This appliance can be used by children aged from 8 years and above and persons with reduced physical, sensory or mental capabilities or lack of experience and knowledge if they have been given supervision or instruction concerning the use of the appliance in a safe way and understand the hazards involved.
- Children between 3 and 8 years of age and persons with very extensive and complex disabilities shall be kept away from the appliance unless continuously supervised.
- Children of less than 3 years of age should be kept away from the appliance unless continuously supervised.
- Do not let children play with the appliance.
- Keep detergents away from children.
- Keep children and pets away from the appliance when the door is open.
- Children shall not carry out cleaning and user maintenance of the appliance without supervision.

1.2 General Safety

- This appliance is intended to be used in household and similar applications such as:
 - farm houses; staff kitchen areas in shops, offices and other working environments;
 - by clients in hotels, motels, bed & breakfast and other residential type environments.
- Do not change the specification of this appliance.

- The operating water pressure (minimum and maximum) must be between 0.5 (0.05) / 8 (0.8) bar (MPa)
- Follow the maximum number of 13 place settings.
- If the supply cord is damaged, it must be replaced by the manufacturer, its Authorised Service Centre or similarly qualified persons in order to avoid a hazard.
- Put the cutlery in the cutlery basket with the sharp ends pointing down or put them in the cutlery drawer in a horizontal position with the sharp edges down.
- Do not leave the appliance with the open door unattended to avoid stepping accidentally onto it.
- Before any maintenance operation, deactivate the appliance and disconnect the mains plug from the socket.
- Do not use high pressure water sprays and/or steam to clean the appliance.
- If the appliance has ventilation openings in the base, they must not be covered e.g. by a carpet.
- The appliance is to be connected to the water mains using the new supplied hose-sets. Old hose sets must not be reused.

2. SAFETY INSTRUCTIONS

2.1 Installation



WARNING!

Only a qualified person must install this appliance.

- Remove all the packaging.
- Do not install or use a damaged appliance.
- Follow the installation instructions supplied with the appliance.
- Always take care when moving the appliance as it is heavy. Always use safety gloves and enclosed footwear.
- Do not install or use the appliance where the temperature is less than 0 °C.
- Install the appliance in a safe and suitable place that meets installation requirements.

2.2 Electrical connection



WARNING!

Risk of fire and electric shock.

- The appliance must be earthed.
- Make sure that the parameters on the rating plate are compatible with the electrical ratings of the mains power supply.
- Always use a correctly installed shockproof socket.
- Do not use multi-plug adapters and extension cables.
- Make sure not to cause damage to the mains plug and to the mains cable. Should the mains cable need to be replaced, this must be carried out by our Authorised Service Centre.

- Connect the mains plug to the mains socket only at the end of the installation. Make sure that there is access to the mains plug after the installation.
- Do not pull the mains cable to disconnect the appliance. Always pull the mains plug.
- This appliance is fitted with a 13 A mains plug. If it is necessary to change the mains plug fuse, use only a 13 A ASTA (BS 1362) fuse (UK and Ireland only).
- Dishwasher detergents are dangerous. Follow the safety instructions on the detergent packaging.
- Do not drink and play with the water in the appliance.
- Do not remove the dishes from the appliance until the programme is complete. Some detergent may remain on the dishes.
- Do not sit or stand on the open door of the appliance.
- The appliance can release hot steam if you open the door while a programme operates.

2.3 Water connection

- Do not cause damage to the water hoses.
- Before connection to new pipes, pipes not used for a long time, where repair work has been carried out or new devices fitted (water meters, etc.), let the water flow until it is clean and clear.
- Ensure that there are no visible water leaks during and after the first use of the appliance.
- If the water inlet hose is damaged, immediately close the water tap and disconnect the mains plug from the mains socket. Contact the Authorised Service Centre to replace the water inlet hose.

2.4 Use

- Do not put flammable products or items that are wet with flammable products in, near or on the appliance.

2.5 Service

- To repair the appliance contact the Authorised Service Centre.
- Use original spare parts only.

2.6 Disposal



WARNING!

Risk of injury or suffocation.

- Disconnect the appliance from the mains supply.
- Cut off the mains cable and discard it.
- Remove the door catch to prevent children and pets to get closed in the appliance.

3. PRODUCT DESCRIPTION

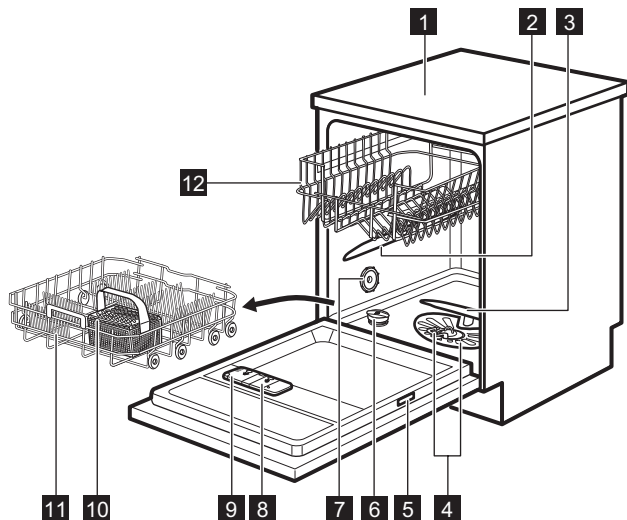



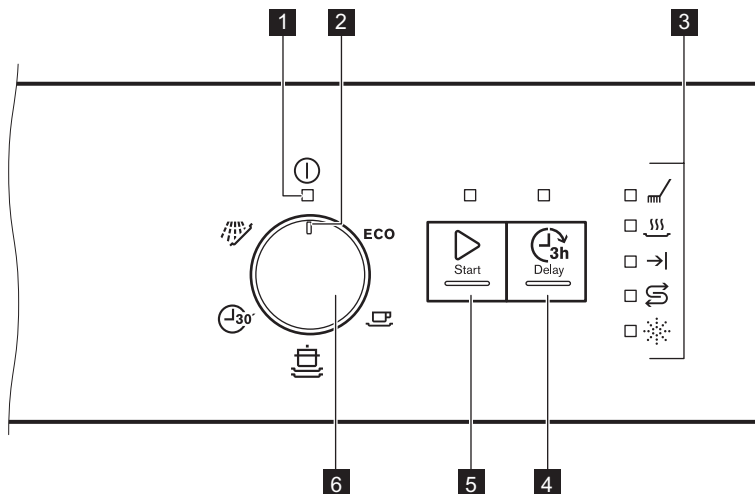

- | | | | |
|----------|-----------------|-----------|---------------------|
| 1 | Worktop | 8 | Rinse aid dispenser |
| 2 | Upper spray arm | 9 | Detergent dispenser |
| 3 | Lower spray arm | 10 | Cutlery basket |
| 4 | Filters | 11 | Lower basket |
| 5 | Rating plate | 12 | Upper basket |
| 6 | Salt container | | |
| 7 | Air vent | | |

4. CONTROL PANEL







- | | |
|---------------------------|-------------------------|
| 1 On/off indicator | 5 Start button |
| 2 Programme marker | 6 Programme knob |
| 3 Indicators | |
| 4 Delay button | |

4.1 Indicators

Indicator	Description
	Washing phase. It comes on when the washing phase operates.
	Drying phase. It comes on when the drying phase operates.
	End indicator.
	Rinse aid indicator. It is always off while the programme operates.
	Salt indicator. It is always off while the programme operates.

5. PROGRAMMES

The order of the programmes in the table may not reflect their sequence on the control panel.

Programme	Degree of soil Type of load	Programme phases	Consumption values 1)		
			Duration (min)	Energy (kWh)	Water (l)
ECO 2)	Normal soil Crockery and cutlery	<ul style="list-style-type: none"> • Prewash • Wash 50 °C • Rinses • Dry 	227	1.039	11
	Heavy soil Crockery, cut- lery, pots and pans	<ul style="list-style-type: none"> • Prewash • Wash 70 °C • Rinses • Dry 	155 - 170	1.5 - 1.7	14 - 15
	Normal soil Crockery and cutlery	<ul style="list-style-type: none"> • Prewash • Wash 65 °C • Rinses • Dry 	130 - 140	1.4 - 1.6	15 - 17
	Fresh soil Crockery and cutlery	<ul style="list-style-type: none"> • Wash 60 °C or 65 °C • Rinses 	30	0.8	10
	All	<ul style="list-style-type: none"> • Prewash 	14	0.1	5

1) The pressure and the temperature of the water, the variations of the mains supply, the options and the quantity of dishes can change the values.

2) This programme offers the most efficient use of water and energy consumption for crockery and cutlery with normal soil. This is the standard programme for test institutes.

3) This programme is suitable for washing a load or a half load with fresh or light soil in a short time.

4) With this programme, you can quickly rinse off food remains from dishes and prevent odours forming in the appliance. Do not use detergent with this programme.

5.1 Information for test institutes

To receive the necessary information for conducting performance tests (e.g. according to EN60436), send an email to:

info.test@dishwasher-production.com

In your request please include the product number code (PNC) found on the rating plate.

For any other questions regarding your dishwasher please refer to the service book provided with your appliance.

6. SETTINGS

6.1 Programme selection mode and user mode

When the appliance is in programme selection mode it is possible to set a programme and to enter the user mode.

Settings available in the user mode:

- The level of water softener according to the water hardness.
- Activation or deactivation of AirDry.

As the appliance stores the saved settings, there is no need to configure it before every cycle.

How to set the programme selection mode

The appliance is in programme selection mode when the on/off indicator is on and Start indicator flashes.

After activation, the appliance is in programme selection mode by default. If not, set the programme selection mode the following way:

Press and hold simultaneously **Start** and **Delay** until the appliance is in programme selection mode.

6.2 The water softener

The water softener removes minerals from the water supply, which would have a negative effect on the washing results and on the appliance.

The higher the content of these minerals, the harder your water is. Water hardness is measured in equivalent scales.

The water softener should be adjusted according to the hardness of the water in your area. Your local water authority can advise you on the hardness of the water in your area. It is important to set the right level of the water softener to assure good washing results.



Softening hard water increases the consumption of water and energy as well as the programme duration. The higher the level of water softener, the higher the consumption and the longer the duration.

Water hardness

German de-grees (°dH)	French de-grees (°fH)	mmol / l	Clarke de-grees	Water softener level
47 - 50	84 - 90	8.4 - 9.0	58 - 63	10
43 - 46	76 - 83	7.6 - 8.3	53 - 57	9
37 - 42	65 - 75	6.5 - 7.5	46 - 52	8
29 - 36	51 - 64	5.1 - 6.4	36 - 45	7
23 - 28	40 - 50	4.0 - 5.0	28 - 35	6
19 - 22	33 - 39	3.3 - 3.9	23 - 27	5 ¹⁾
15 - 18	26 - 32	2.6 - 3.2	18 - 22	4
11 - 14	19 - 25	1.9 - 2.5	13 - 17	3
4 - 10	7 - 18	0.7 - 1.8	5 - 12	2
<4	<7	<0.7	< 5	1 ²⁾

1) Factory setting.

2) Do not use salt at this level.

Regardless of the type of detergent used, set the proper water hardness level to keep the salt refill indicator active.



Multi-tabs containing salt are not effective enough to soften hard water.

How to set the water softener level

The appliance must be in programme selection mode.

1. Make sure that the programme marker on the knob is in on/off position.
2. To enter the user mode, press and hold **Delay**. At the same time turn the knob counterclockwise until the programme marker indicates the first programme. Release the **Delay** when the indicators **Start** and on/off start flashing.
 - The intermittent flashing of  shows the current setting, e.g. 5 flashes + pause + 5 flashes = level 5.
3. Press **Delay** repeatedly to change the setting. Each pressing of **Delay** increases the level number. After reaching level 10, the count starts again from level 1.
4. To confirm the setting, turn the programme knob until the programme marker is again in on/off position

6.3 AirDry

AirDry improves the drying results with less energy consumption.

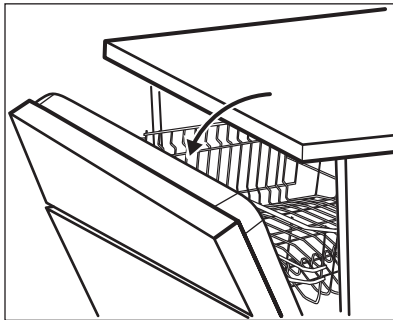

During the drying phase, the door opens automatically and remains ajar.



CAUTION!

Do not try to close the appliance door within 2 minutes after automatic opening. This can cause damage to the appliance.

AirDry is automatically activated with all programmes excluding  (if applicable).





CAUTION!

If children have access to the appliance, it is advised to deactivate AirDry as opening the door may pose a danger.

How to deactivate AirDry

The appliance must be in programme selection mode.

Make sure that the programme marker on the knob is set to **on/off** position.

1. To enter the user mode, press and hold **Delay**. At the same time turn the knob counterclockwise until the programme marker indicates the first programme. Release **Delay** when the indicators **Start** and on/off start flashing.
2. Turn the knob counterclockwise until the programme marker indicates the second programme.
 - The indicator  shows the current setting: on = AirDry is activated.
3. Press **Delay** to change the setting.
 - If the indicator  is off = AirDry is deactivated.
4. To confirm the setting, keep turning the programme knob until the programme marker is back in the **on/off** position.

7. BEFORE FIRST USE

1. **Make sure that the current level of the water softener agrees with the hardness of the water supply. If not, adjust the level of the water softener.**
2. Fill the salt container.
3. Fill the rinse aid dispenser.
4. Open the water tap.
5. Start a programme to remove any processing residuals that can still be inside the appliance. Do not use

detergent and do not put dishes in the baskets.

After starting the programme, the appliance recharges the resin in the water softener for up to 5 minutes. The washing phase starts only after this procedure is complete. The procedure is repeated periodically.

7.1 The salt container



CAUTION!
Use rough salt designed for dishwashers only. Fine salt increases the risk of corrosion.

The salt is used to recharge the resin in the water softener and to assure good washing results in daily use.

How to fill the salt container

1. Turn the cap of the salt container counterclockwise and remove it.
2. Put 1 litre of water in the salt container (only for the first time).
3. Fill the salt container with 1 kg of salt (until it is full).



4. Carefully shake the funnel by its handle to get the last granules inside.
5. Remove the salt around the opening of the salt container.

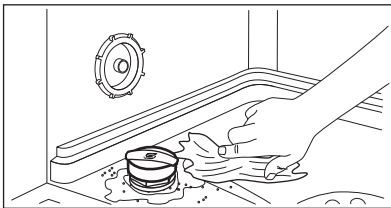

6. Turn the cap of the salt container clockwise to close the salt container.



CAUTION!
Water and salt can come out of the salt container when you fill it. After you fill the salt container, immediately start a programme to prevent corrosion.

7.2 How to fill the rinse aid dispenser

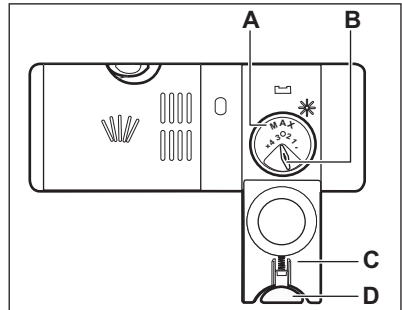
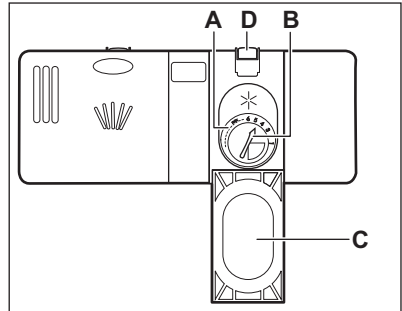

CAUTION!
Only use rinse aid specifically designed for dishwashers.

1. Press the release button (D) to open the lid (C).
2. Pour the rinse aid in the dispenser (A) until the liquid reaches the fill level 'max'.
3. Remove the spilled rinse aid with an absorbent cloth to prevent too much foam.
4. Close the lid. Make sure that the release button locks into position.



You can turn the selector of the released quantity (**B**) between position 1 (lowest quantity) and position 4 or 6 (highest quantity).

8. DAILY USE

1. Open the water tap.
2. Turn the knob until the programme marker is aligned with the programme you want to set. Set the correct programme for the type of load and the degree of soil.
 - If the salt indicators is on, fill the salt container.
 - If the rinse aid indicator is on, fill the rinse aid dispenser.
3. Load the baskets.
4. Add the detergent.
5. Start the programme.

8.1 Using the detergent

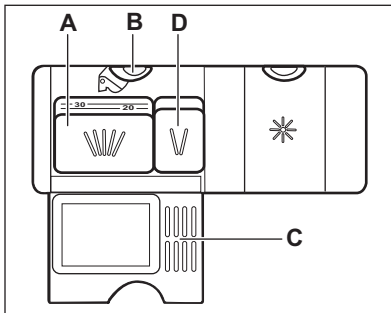
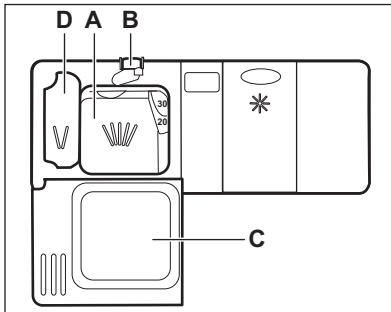

1. Press the release button (**B**) to open the lid (**C**).
2. Put the detergent, in powder or tablets, in the compartment (**A**).

3. If the programme has a prewash phase, put a small quantity of detergent in the compartment (**D**).
4. Close the lid. Make sure that the release button locks into position.

8.2 Using the multi-tablets

When you use tablets, that contain salt and rinse aid, do not fill the salt container and the rinse aid dispenser.

1. Adjust the water softener to the lowest level.
2. Set the rinse aid dispenser to the lowest position.

8.3 Setting and starting a programme

Starting a programme

1. Open the water tap.
2. Close the appliance door.
3. Turn the knob until the programme marker is aligned with the programme you want to set.
 - On/off indicator comes on.
 - Start indicator starts to flash.
4. Press **Start**.
 - The programme starts and the indicator of the washing phase is on.
 - On/off indicator and start indicator are on.

Starting a programme with delay start

1. Set the programme.
2. Press **Delay** to delay the start of the programme of 3 hours. The delay indicator comes on.
3. Press **Start**.

Start indicator comes on.
When the countdown is completed, the programme starts.

Opening the door while the appliance operates

Opening the door while a programme is running stops the appliance. It may affect the energy consumption and the programme duration. After closing the door, the appliance continues from the point of interruption.

i If the door is opened for more than 30 seconds during the drying phase, the running programme ends. It does not happen if the door is opened by AirDry function.

i Do not try to close the appliance door within 2 minutes after AirDry automatically opens it, as this may cause damage to the appliance. If, afterwards, the door is closed for another 3 minutes, the running programme ends.

Cancelling the delay start while the countdown operates

1. Press and hold **Start** and **Delay** until the start indicator starts to flash.
2. Press **Start** to start the programme.

Cancelling the programme

Press and hold **Start** and **Delay** until the start indicator starts to flash. Make sure that there is detergent in the detergent dispenser before you start a new programme.

End of the programme

When the programme is completed the →| indicator is on. After 5 minutes of non-use, the appliance enters standby mode and all the indicators are off. It decreases energy consumption.

1. To deactivate the appliance, turn the programme knob until the programme marker is in on/off position.
2. Close the water tap.

9. HINTS AND TIPS

9.1 General

Follow the hints below to ensure optimal cleaning and drying results in daily use and to help you protect the environment.

- Remove larger residues of food from the dishes into the waste bin.
- Do not pre-rinse dishes by hand. When needed, select a programme with a prewash phase.
- Always use the whole space of the baskets.
- Make sure that items in the baskets do not touch or cover each other. Only then can the water completely reach and wash the dishes.
- You can use dishwasher detergent, rinse aid and salt separately or you can use the multi-tablets (e.g. "All in 1"). Follow the instructions on the packaging.

- Select a programme according to the type of load and the degree of soil.

ECO offers the most efficient use of water and energy consumption.

9.2 Using salt, rinse aid and detergent

- Only use salt, rinse aid and detergent for dishwasher. Other products can cause damage to the appliance.
- In areas with hard and very hard water we recommend to use plain dishwasher detergent (powder, gel, tablets containing no additional agents), rinse aid and salt separately for optimal cleaning and drying results.
- At least once a month run the appliance with the use of appliance

cleaner which is particularly suitable for this purpose.

- Detergent tablets do not fully dissolve with short programmes. To prevent detergent residues on the tableware, we recommend that you use the tablets with long programmes.
- Do not use more than the correct quantity of detergent. Refer to the instructions on the detergent packaging.

9.3 What to do if you want to stop using multi-tablets

Before you start to use separately detergent, salt and rinse aid do the following procedure.

1. Set the highest level of the water softener.
2. Make sure that the salt and rinse aid containers are full.
3. Start the shortest programme with a rinsing phase. Do not add detergent and do not load the baskets.
4. When the programme is completed, adjust the water softener according to the water hardness in your area.
5. Adjust the released quantity of rinse aid.

9.4 Loading the baskets

- Use the appliance to wash dishwasher-safe items only.
- Do not wash in the appliance items made of wood, horn, aluminium, pewter and copper.
- Do not wash in the appliance items that can absorb water (sponges, household cloths).
- Remove large food residues from dishes.
- Soak cookware with burnt-on food before washing it in the appliance.

- Put hollow items (cups, glasses and pans) with the opening facing downwards.
- Make sure that glasses do not touch each other.
- Put light items in the upper basket. Make sure that the items do not move freely.
- Put cutlery and small items in the cutlery basket.
- Make sure that the spray arms can move freely before you start a programme.

9.5 Before starting a programme

Before you start the selected programme, make sure that:

- The filters are clean and correctly installed.
- The cap of the salt container is tight.
- The spray arms are not clogged.
- There is enough salt and rinse aid (unless you use multi-tablets).
- The arrangement of the items in the baskets is correct.
- The programme is suitable to the type of load and the degree of soil.
- The correct quantity of detergent is used.

9.6 Unloading the baskets

1. Let the tableware cool down before you remove it from the appliance. Hot items can be easily damaged.
2. First remove items from the lower basket, then from the upper basket.



After the programme is completed, water can still remain on the inside surfaces of the appliance.

10. CARE AND CLEANING



WARNING!

Before maintenance, deactivate the appliance and disconnect the mains plug from the main socket.



Dirty filters and clogged spray arms decrease the washing results. Make a check regularly and, if necessary, clean them.

10.1 Cleaning the filters

The filter system is made of 3 parts.

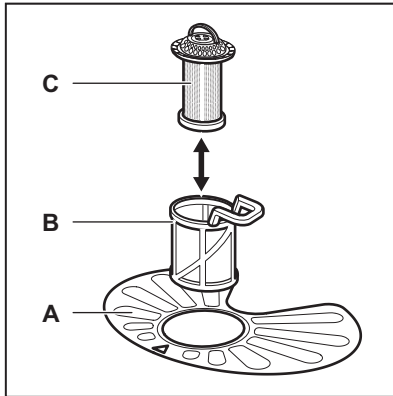

1. Turn the filter (B) counterclockwise and remove it.

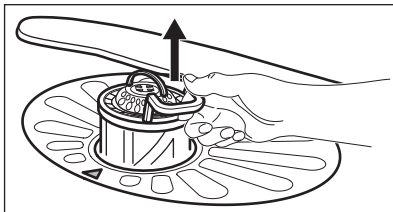
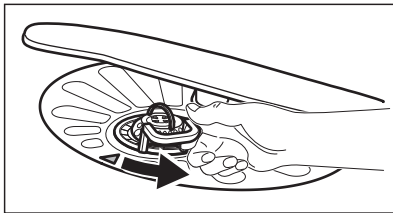

2. Remove the filter (C) out of filter (B).
3. Remove the flat filter (A).

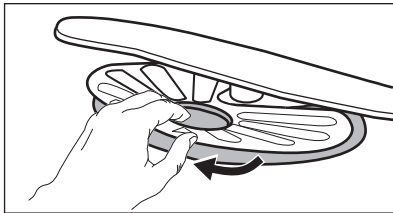

4. Wash the filters.

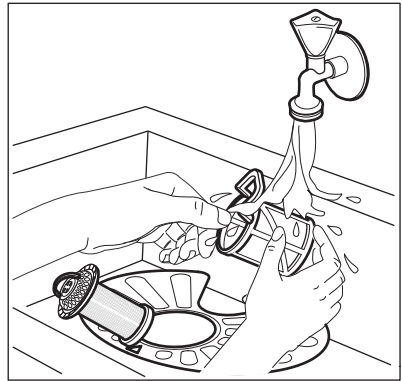

5. Make sure that there are no residues of food or soil in or around the edge of the sump.
6. Put back in place the flat filter (A). Make sure that it is correctly positioned under the 2 guides.

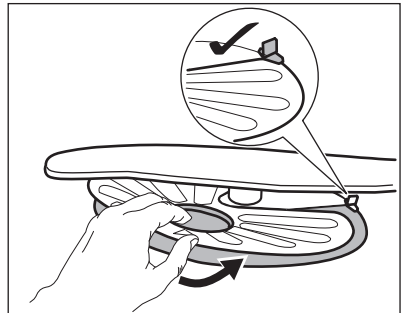

7. Reassemble the filters (B) and (C).
8. Put back the filter (B) in the flat filter (A). Turn it clockwise until it locks.

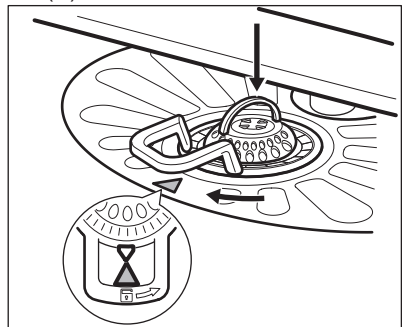

CAUTION!

An incorrect position of the filters can cause bad washing results and damage to the appliance.

10.2 Cleaning the spray arms

Do not remove the spray arms. If the holes in the spray arms are clogged, remove remaining parts of soil with a thin pointed object.

10.3 External cleaning

- Clean the appliance with a moist soft cloth.
- Only use neutral detergents.
- Do not use abrasive products, abrasive cleaning pads or solvents.

10.4 Internal cleaning

- Carefully clean the appliance, including the rubber gasket of the door, with a soft damp cloth.

- If you regularly use short duration programmes, these can leave deposits of grease and limescale inside the appliance. To prevent this, we recommend to run long duration programmes at least 2 times per month.
- To maintain the performance of your appliance at its best, we recommend to use monthly a specific cleaning product for dishwashers. Follow carefully the instructions on the packaging of the product.

11. TROUBLESHOOTING

If the appliance does not start or it stops during operation, before you contact an Authorised Service Centre, check if you can solve the problem by yourself with the help of the information in the table.



WARNING!

Repairs not properly done may result in serious risk to the safety of the user. Any repairs must be performed by qualified personnel.

With some problems the end indicator flashes intermittently indicating a malfunction.

The majority of problems that can occur can be solved without the need to contact an Authorised Service Centre.

Problem and alarm code	Possible cause and solution
You cannot activate the appliance.	<ul style="list-style-type: none"> • Make sure that the mains plug is connected to the mains socket. • Make sure that there is no damaged fuse in the fuse box.
The programme does not start.	<ul style="list-style-type: none"> • Make sure that the appliance door is closed. • Press Start. • If the delay start is set, cancel the setting or wait for the end of the countdown. • The appliance has started the procedure to recharge the resin inside the water softener. The duration of the procedure is approximately 5 minutes.

Problem and alarm code	Possible cause and solution
<p>The appliance does not fill with water.</p> <ul style="list-style-type: none"> • The end indicator flashes 1 time intermittently. • The Start indicator flashes continuously. 	<ul style="list-style-type: none"> • Make sure that the water tap is open. • Make sure that the pressure of the water supply is not too low. For this information, contact your local water authority. • Make sure that the water tap is not clogged. • Make sure that the filter in the inlet hose is not clogged. • Make sure that the inlet hose has no kinks or bends.
<p>The appliance does not drain the water.</p> <ul style="list-style-type: none"> • The end indicator flashes 2 times intermittently. • The Start indicator flashes continuously. 	<ul style="list-style-type: none"> • Make sure that the sink spigot is not clogged. • Make sure that the drain hose has no kinks or bends.
<p>The anti-flood device is on.</p> <ul style="list-style-type: none"> • The end indicator flashes 3 times intermittently. • The Start indicator flashes continuously. 	<ul style="list-style-type: none"> • Close the water tap and contact an Authorised Service Centre.
<p>The appliance stops and starts more times during operation.</p>	<ul style="list-style-type: none"> • It is normal. It provides optimal cleaning results and energy savings.
<p>The program lasts too long.</p>	<ul style="list-style-type: none"> • If the delayed start option is set, cancel the delay setting or wait for the end of the countdown.
<p>Small leak from the appliance door.</p>	<ul style="list-style-type: none"> • The appliance is not levelled. Loosen or tighten the adjustable feet (if applicable). • The appliance door is not centred on the tub. Adjust the rear foot (if applicable).
<p>The appliance door is difficult to close.</p>	<ul style="list-style-type: none"> • The appliance is not levelled. Loosen or tighten the adjustable feet (if applicable). • Parts of the tableware are protruding from the baskets.
<p>Rattling/knocking sounds from inside the appliance.</p>	<ul style="list-style-type: none"> • The tableware is not properly arranged in the baskets. Refer to basket loading leaflet. • Make sure that the spray arms can rotate freely.
<p>The appliance trips the circuit-breaker.</p>	<ul style="list-style-type: none"> • The amperage is insufficient to supply simultaneously all the appliances in use. Check the socket amperage and the capacity of the meter or turn off one of the appliances in use. • Internal electrical fault of the appliance. Contact an Authorised Service Centre.



Refer to "**Before first use**", "**Daily use**", or "**Hints and tips**" for other possible causes.

For alarm codes not described in the table, contact an Authorised Service Centre.

Once you have checked the appliance, press **Start**. If the problem occurs again, contact an Authorised Service Centre.

11.1 The washing and drying results are not satisfactory

Problem	Possible cause and solution
Poor washing results.	<ul style="list-style-type: none"> Refer to "Daily use", "Hints and tips" and basket loading leaflet. Use more intensive washing programmes. Clean spray arm jets and filter. Refer to "Care and Cleaning".
Poor drying results.	<ul style="list-style-type: none"> Tableware has been left for too long inside a closed appliance. There is no rinse aid or the dosage of rinse aid is not enough. Set the rinse aid dispenser to a higher level. Plastic items may need to be towel dried. For the best drying performance activate AirDry. We recommend to always use rinse aid, even in combination with multi-tablets.
There are whitish streaks or bluish layers on glasses and dishes.	<ul style="list-style-type: none"> The release quantity of rinse aid is too much. Adjust the rinse aid level to a lower level. The quantity of detergent is too much.
There are stains and dry water drops on glasses and dishes.	<ul style="list-style-type: none"> The released quantity of rinse aid is not sufficient. Adjust the rinse aid level to a higher level. The quality of the rinse aid can be the cause.
The dishes are wet.	<ul style="list-style-type: none"> For the best drying performance activate AirDry. The programme does not have a drying phase or has a drying phase with low temperature. The rinse aid dispenser is empty. The quality of the rinse aid can be the cause. The quality of the multi-tablets can be the cause. Try a different brand or activate the rinse aid dispenser and use rinse aid and multi-tablets together.
The interior of the appliance is wet.	<ul style="list-style-type: none"> This is not a defect of the appliance. It is caused by the humidity in the air that condenses on the walls.
Unusual foam during washing.	<ul style="list-style-type: none"> Use the detergent for dishwashers only. There is a leak in the rinse aid dispenser. Contact an Authorised Service Centre.

Problem	Possible cause and solution
Traces of rust on cutlery.	<ul style="list-style-type: none"> • There is too much salt in the water used for washing. Refer to "The water softener". • Silver and stainless steel cutlery were placed together. Avoid to put silver and stainless steel items close together.
There are residues of detergent in the dispenser at the end of the programme.	<ul style="list-style-type: none"> • The detergent tablet got stuck in the dispenser and therefore was not completely washed away by water. • Water cannot wash away the detergent from the dispenser. Make sure that the spray arm is not blocked or clogged. • Make sure that items in the baskets do not impede the lid of the detergent dispenser from opening.
Odours inside the appliance.	<ul style="list-style-type: none"> • Refer to "Internal cleaning".
Limescale deposits on the tableware, on the tub and on the inside of the door.	<ul style="list-style-type: none"> • The level of salt is low, check the refill indicator. • The cap of the salt container is loose. • Your tap water is hard. Refer to "The water softener". • Even using multi-functional tabs use salt and set regeneration of the water softener. Refer to "The water softener". • If lime scale deposits still remain, clean the appliance with appliance cleaners which are particularly suitable for this purpose. • Try different detergent. • Contact the detergent manufacturer.
Dull, discoloured or chipped tableware.	<ul style="list-style-type: none"> • Make sure that only dishwasher-safe items are washed in the appliance. • Load and unload the basket carefully. Refer to basket loading leaflet. • Place delicate items in the upper basket.



Refer to "**Before first use**", "**Daily use**" or "**Hints and tips**" for other possible causes.

12. PRODUCT INFORMATION SHEET

Trade Mark	Electrolux
Model	ESF5206LOW 911519220
Rated capacity (standard place settings)	13
Energy efficiency class	A+

Energy consumption in kWh per year, based on 280 standard cleaning cycles using cold water fill and the consumption of the low power modes. The actual energy consumption will depend on how the appliance is used.	295
Energy consumption of standard cleaning cycle (kWh)	1.039
Power consumption in off mode (W)	0.50
Power consumption in left-on mode (W)	5.0
Water consumption in litres per year, based on 280 standard cleaning cycles. The actual water consumption will depend on how the appliance is used	3080
Drying efficiency class on a scale from G (least efficient) to A (most efficient)	A
The 'standard programme' is the standard cleaning cycle to which the information in the label and the fiche relates. This programme is suitable to clean normally soiled tableware and is the most efficient programme in terms of combined energy and water consumption. It is indicated as "Eco" programme.	ECO
Programme time of standard cleaning cycle (min)	227
Duration of the left-on mode (min)	5
Sound power level (db(A) re 1pW)	49
Built in appliance Y/N	No

13. ADDITIONAL TECHNICAL INFORMATION

Dimensions	Width / height / depth (mm)	600 / 850 / 625
Electrical connection ¹⁾	Voltage (V)	220 - 240
	Frequency (Hz)	50
Water supply pressure	Min. / max. bar (MPa)	0.5 (0.05) / 8 (0.8)
Water supply	Cold water or hot water ²⁾	max 60 °C

¹⁾ Refer to the rating plate for other values.

²⁾ If the hot water comes from alternative source of energy (e.g. solar panels), use the hot water supply to decrease energy consumption.

14. ENVIRONMENTAL CONCERNS

Recycle materials with the symbol .
Put the packaging in relevant containers to recycle it. Help protect the

environment and human health by recycling waste of electrical and electronic appliances. Do not dispose of

appliances marked with the symbol  with the household waste. Return the

product to your local recycling facility or contact your municipal office.

www.electrolux.com/shop



156932042-A-362019

